

# Mud-In Mounting Channel

Aluminum Channel for Flexible LED Strip

D-181102

## Installation Diagram

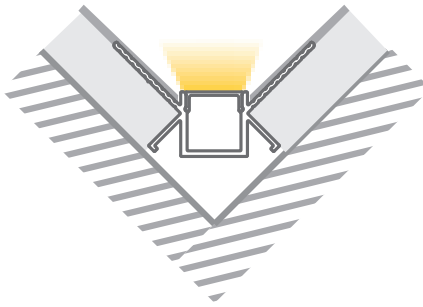

## Specifications

- Material: Anodized Aluminum 6063
- Color: Silver / Black / White
- Cover: Regular PC diffuser (milky / transparent / black)
- Width\*Height: 46\*26mm [1.81\*1.02in.]
- Max. Length: Profile 3M [9.84ft.], cover 20M[65.6ft.]
- End cap: 2pcs/unit (1pc with hole, 1pc without hole)
- Clip/Screw:
- Match Strip Width: 8/10/12mm [0.31/0.39/0.47in.]
- Linear LED Density@milky cover:  $\geq 120\text{LED/M/Row}$  [36LED/ft.]
- Light Output Rate of Finished Product: 30-40%
- Length of Finished Product: Strip Length+13mm [0.51in.]

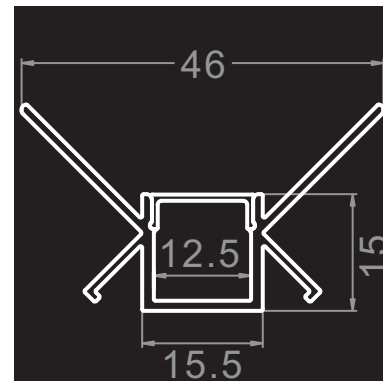

## Part Number

MODEL	CHANNEL FINISH	LENS	QUANTITY
D-181102	Mud-In Mounting Channel <b>WH</b> White <b>SI</b> Silver <b>BK</b> Black	<b>C</b> Clear Lens <b>F</b> Frosted Lens <b>M</b> Milky Lens	<b>39</b> Available in 1 meter (39") increments

# Mud-In Mounting Channel

## Aluminum Channel for Flexible LED Strip

D-  
181102

### Aluminum Options

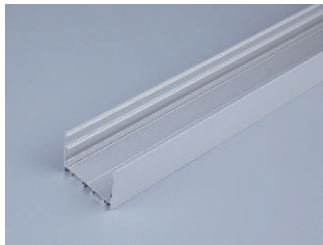

Silver

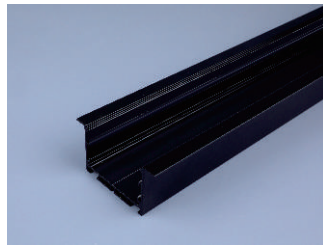

Black



White

### Diffusion PC Cover Options

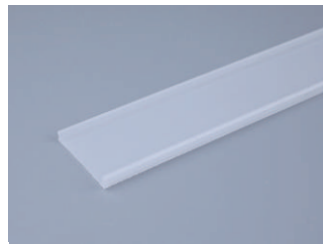

Milky Transmission:  
83%For Dot-free

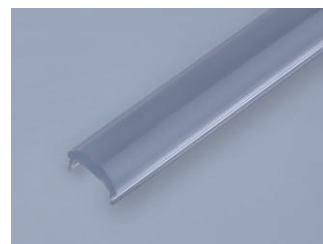

Transparent Transmission:  
93%For High transmittance

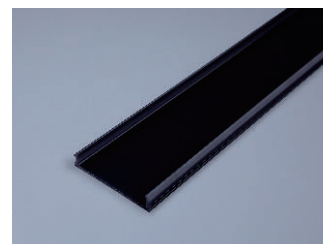

Black Transmission:  
60%For Decoration

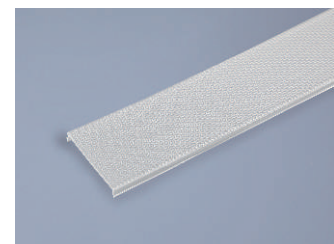

Prismatic Transmission: 83%  
For Anti-glare (UGR < 19 optional)

# Mud-In Mounting Channel

## Compatible LED Strips

D-  
181102

STATIC	RGBW	TW	LED STRIP #	PRODUCT WIDTH	IP rating
✓			HEFC-9682S	0.2" (5mm)	IP20
✓			ICBI-9645S	0.24" (6mm)	IP20
✓			ULHE-9519S	0.32" (8mm)	IP20
✓			ULHE-9522S	0.32" (8mm)	IP20
✓			HEFC-9687S	0.32" (8mm)	IP20
✓			OSMV-FE62S	0.32" (8mm)	IP20
✓			TDFP-414S	0.32" (8mm)	IP54
✓			ULPS-9033S	0.39" (10mm)	IP20
✓			HEFC-9677S	0.39" (10mm)	IP20
✓			ULHE-9561S	0.39" (10mm)	IP20
✓			HEP-L624S	0.39" (10mm)	IP20
	✓		CMLP-9688S	0.39" (10mm)	IP20
		✓	TUNE-LN28S	0.39" (10mm)	IP20
		✓	HEFC-9678S	0.39" (10mm)	IP20
✓			ULPS-LN21S	0.47" (12mm)	IP20
		✓	DTWP-LN27S	0.47" (12mm)	IP20
	✓		CMLP-8707S	0.47" (12mm)	IP20
			CMLP-FE78S	0.47" (12mm)	IP20
	✓		CMLP-9023S	0.47" (12mm)	IP20