

Mud-In Mounting Channel

Aluminum Channel for Flexible LED Strip

D-
386138

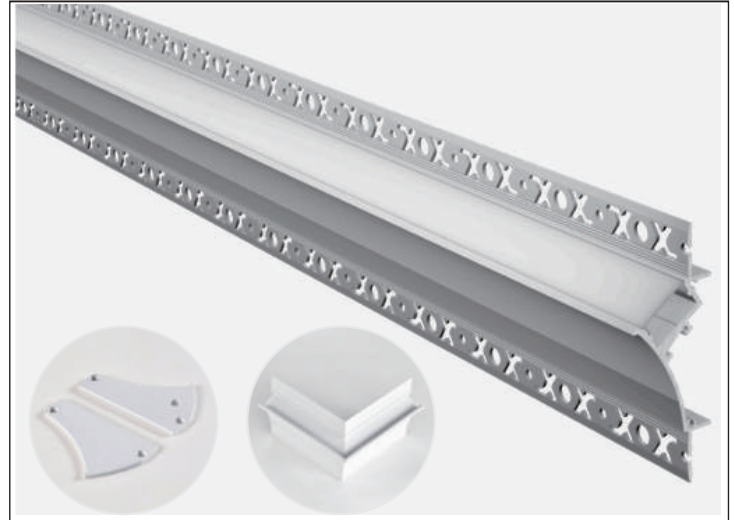
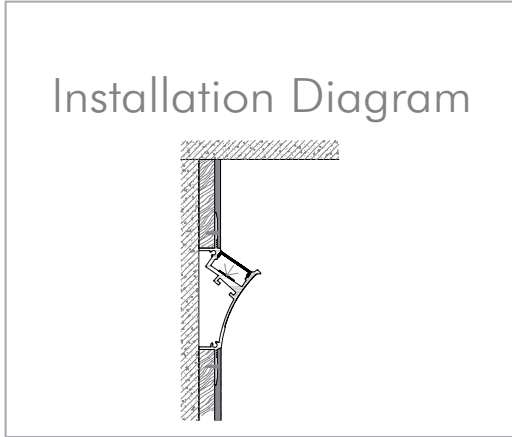

Specifications

- Material: Anodized Aluminum 6063
- Color: Silver / Black / White
- Cover: Regular PC diffuser (milky / transparent / black)
- Width*Height: 98*35mm [3.86*1.38in.]
- Max. Length: Profile 3M [9.84ft.], cover 20M[65.6ft.]
- End cap: 2pcs/unit (1 pc with hole, 1 pc without hole)
- Clip/Screw:
- Match Strip Width: 8/10/12mm [0.31/0.39/0.47in.]
- Linear LED Density@milky cover: ≥120LED/M/Row [36LED/ft.]
- Light Output Rate of Finished Product: 50-60%
- Length of Finished Product: Strip Length + 13mm [0.51in.]

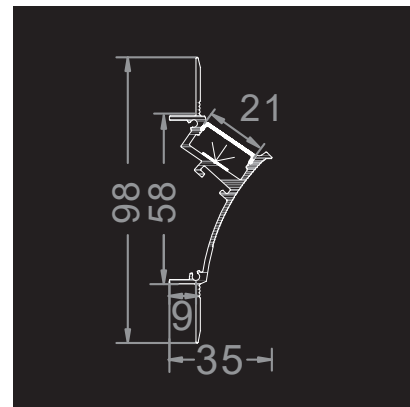

Part Number

MODEL	CHANNEL FINISH	LENS	QUANTITY
D-386138	WH White SI Silver BK Black	C Clear Lens F Frosted Lens M Milky Lens	39 Available in 1 meter (39") increments

Mud-In Mounting Channel

Aluminum Channel for Flexible LED Strip

D-
386138

Aluminum Options

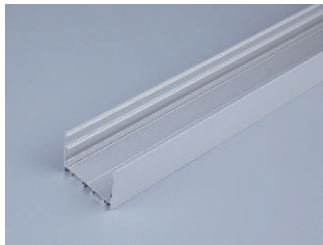

Silver

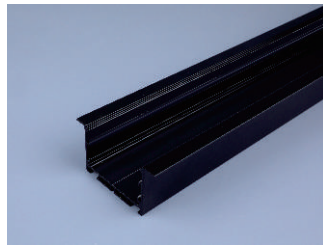

Black



White

Diffusion PC Cover Options

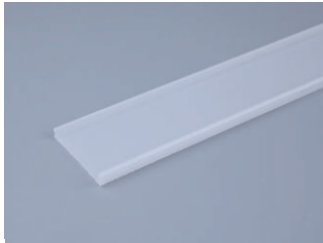

Milky Transmission:
83%For Dot-free

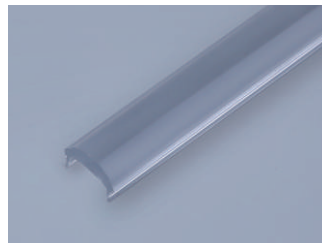

Transparent Transmission:
93%For High transmittance

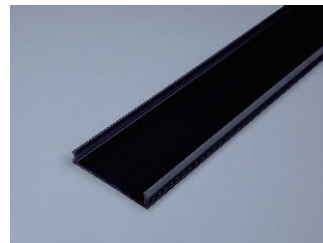

Black Transmission:
60%For Decoration

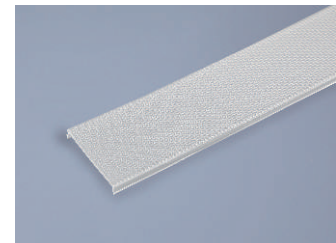

Prismatic Transmission: 83%
For Anti-glare (UGR < 19 optional)

Mud-In Mounting Channel

Compatible LED Strips

D-
386138

STATIC	RGBW	TW	LED STRIP #	PRODUCT WIDTH	IP rating
✓			HEFC-9682S	0.2" (5mm)	IP20
✓			ICBI-9645S	0.24" (6mm)	IP20
✓			ULHE-9519S	0.32" (8mm)	IP20
✓			ULHE-9522S	0.32" (8mm)	IP20
✓			HEFC-9687S	0.32" (8mm)	IP20
✓			OSMV-FE62S	0.32" (8mm)	IP20
✓			TDFP-414S	0.32" (8mm)	IP54
✓			ULPS-9033S	0.39" (10mm)	IP20
✓			HEFC-9677S	0.39" (10mm)	IP20
✓			ULHE-9561S	0.39" (10mm)	IP20
✓			HEP-L624S	0.39" (10mm)	IP20
	✓		CMLP-9688S	0.39" (10mm)	IP20
		✓	TUNE-LN28S	0.39" (10mm)	IP20
		✓	HEFC-9678S	0.39" (10mm)	IP20
✓			ULPS-LN21S	0.47" (12mm)	IP20
		✓	DTWP-LN27S	0.47" (12mm)	IP20
	✓		CMLP-8707S	0.47" (12mm)	IP20
			CMLP-FE78S	0.47" (12mm)	IP20
		✓	CMLP-9023S	0.47" (12mm)	IP20