

LED Strip Light

Dot-Free Pro Series

High-Power High-Efficacy IP67



Features

The TDFP Series is a very flexible, ultra-thin, and dot-free LED strip. With 153 lumens per watt and Standard and High output options, the TDFP boasts a range of output from 555 lumens per foot up to 887 lumens per foot. Premium diffused extruded silicone provides even, consistent illumination. The TDFP offers maximum customization with multiple wattages, channel options, and a segment length of 1.04". Standard color temperatures and IP67 rated.

UL and CE with a 5-year warranty.

Application

Ideal for high-end linear lighting applications in residential, retail, hospitality and landscape settings.



LED Strip Light

Diagram

Option1 : Terminal is sealed with end cap by gluing process.

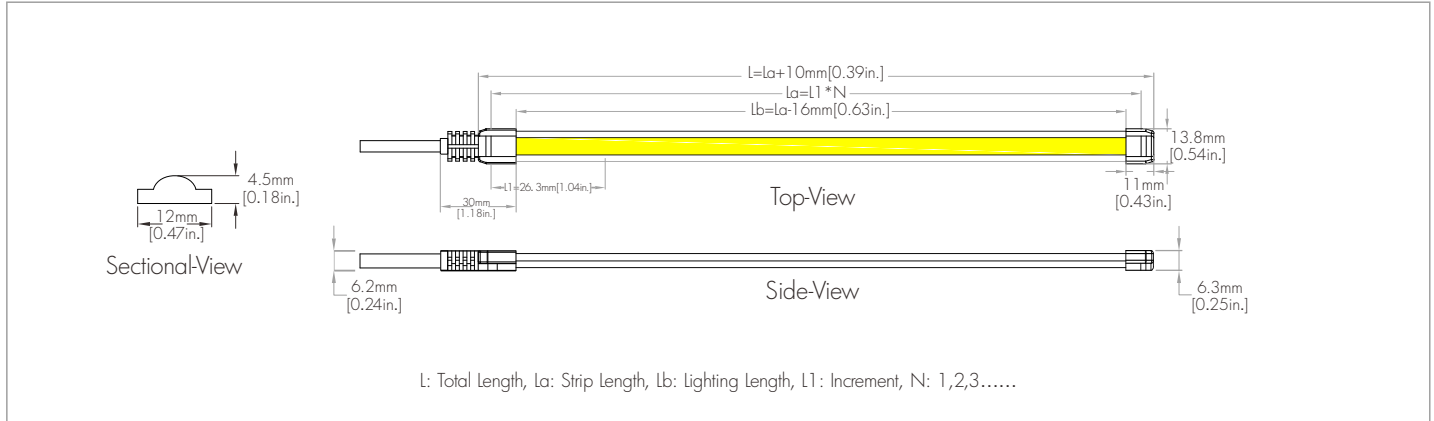

Option2: Terminal is sealed by die-casting process.

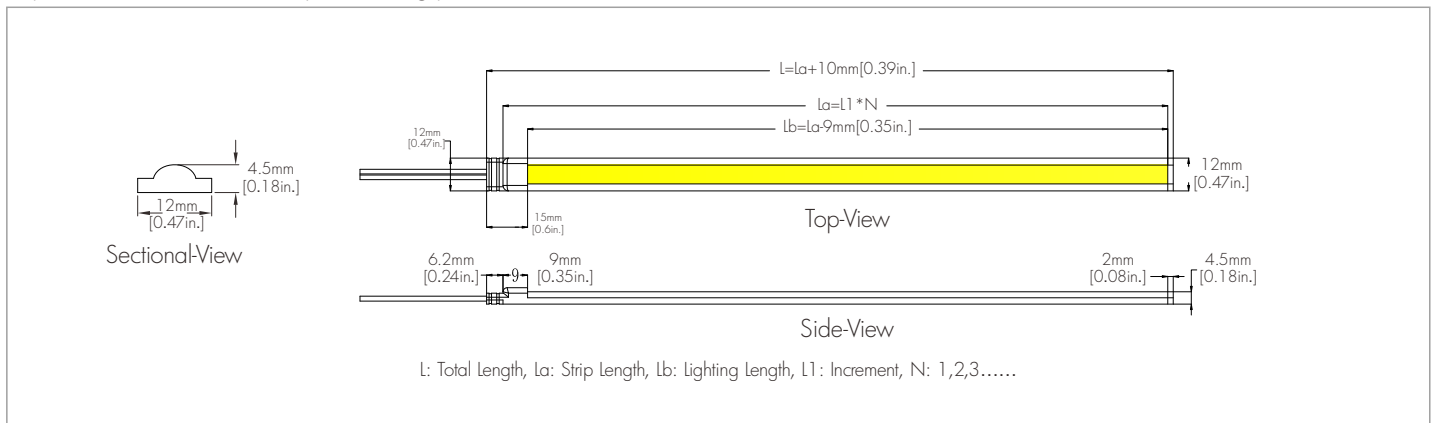

Option3: Terminal is sealed by quick-assembly connector.

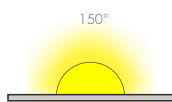
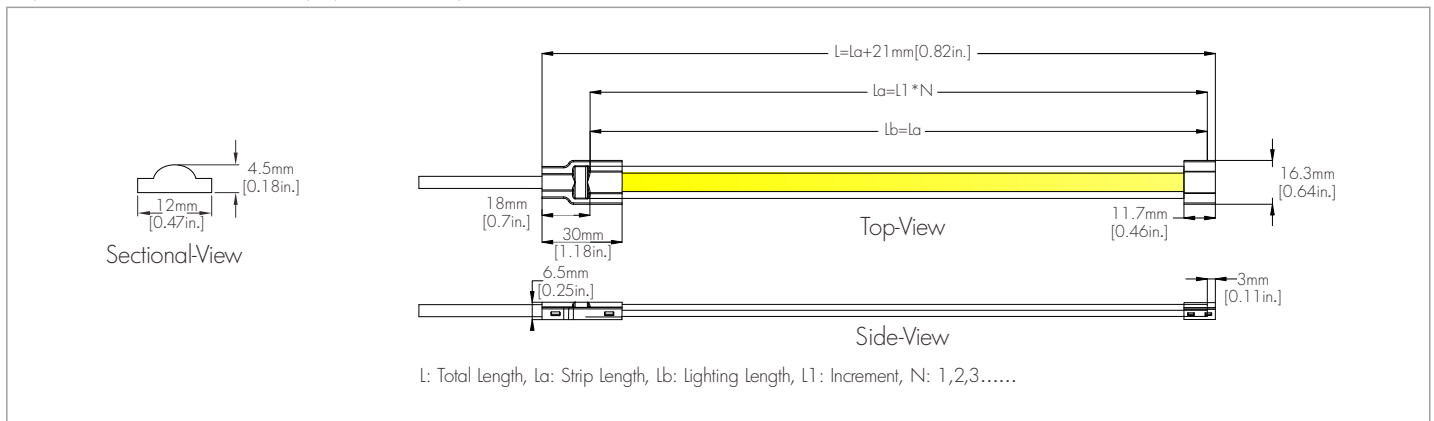

Wide Beam Angle

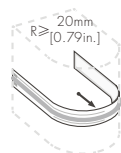

Min. Bending Radius

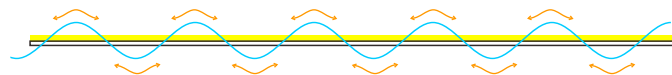

Top Bend Only

LED Strip Light

General Parameters

Part No.	Dimension	Max. Length (La)	Increment (L1)	LED Type	LED QTY	IP Rating	Operating Ambient	Lifespan	Warranty
TDFP-172S	W12*H4.5mm [W0.47*H0.18in.]	5M [16.4ft.] (Power fed on one side)	26.3mm [1.04in.]	SMD2835	304LED/M [92LED/ft.]	IP67 [Wet]	Ta(working): -20~45°C [-4~113°F] & Tstg (storage): -20~60°C [-4~140°F]	50,000h (L70@ Tc≤ 65°C[149°F], Tc is the temp. of LED pin)	5 years

Photoelectric Parameters

Part No.	Power ± 10%	Operating Voltage	Finished Product CCT/ Wavelength	CRI80, 4000K		CRI90, 4000K		Beam Angle
				Luminous Flux± 10%	Light Efficiency	Luminous Flux± 10%	Light Efficiency	
TDFP-172SS	14W/M [4.3W/ft.]	24VDC	2700K±120K 3000K±150K 3500K±300K 4000K±300K 5000K±400K 6500K±500K (LED is 3 step SDCM in 1 bin)	2140lm/M [652lm/ft.]	153lm/W	1820lm/M [555lm/ft.]	130lm/W	150° (perpendicular to the LED strip) & 110° (parallel to the LED strip)
TDFP-172SH	19W/M [5.8W/ft.]			2910lm/M [887lm/ft.]	153lm/W	2470lm/M [753lm/ft.]	130lm/W	

Note:

- (1) The lumen flux value above is base on 1M[3.28ft.] length, it need to be measured and considered separately for other longer lengths.
- (2) Luminous flux for CCT 2700K is 10% lower, for CCT 3000K/3500K is 5% lower, for CCT 5000K/6500K is the same, compared with 4000K.
- (3) Energy efficiency class of regulation (EU)2019/2020 are D(CRI80) and E(CRI90), it varies depending on CCT, CRI and IP rating.
- (4) Applying with extra heat sink for cooling is proposed.
- (5) 3M 300LSE adhesive tape attached on backside, is standard configuration.
- (6) 300mm[11.8in.] length of double insulated PVC cable in one end, white reel and silvery ESD bag, are standard configuration.
- (7) Installation accessories such as clip, screw, connector etc. are all optional base on specific demand.

Light Distribution Diagram

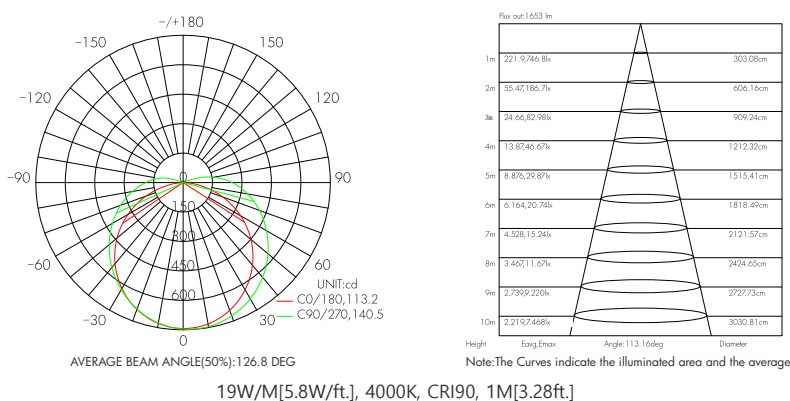
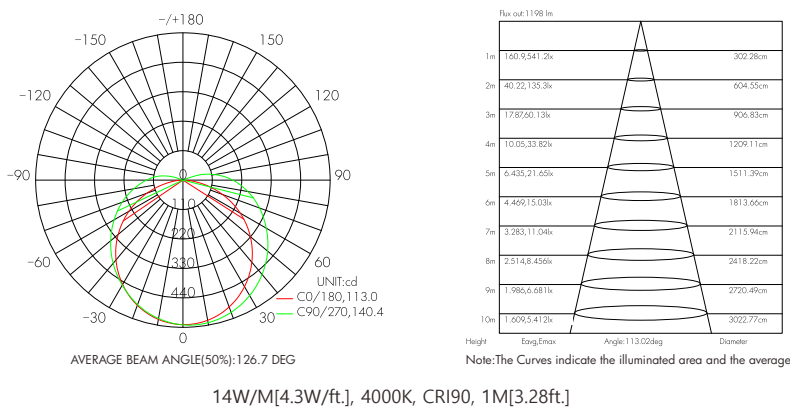

LED Strip Light

Ordering Information

MODEL	COLOR	LENGTH	CRI	VOLTAGE
TDFP-172SS 4.3 Watts/Foot	27K 2700K	16.4 16.4' Reel	80 80+	24 24 Volt DC
TDFP-172SH 5.8 Watts/Foot	30K 3000K 35K 3500K 40K 4000K 50K 5000K 65K 6500K	CU Custom Length	90 90+	

Accessories

- FS-TDFP-172S-WL** Wire lead connector for static white strip
- FS-TDFP-172S-EC** End cap
- FS-TDFP-172S-JC** Jumper cable connector static white strip
- FS-TDFP-172S-SSC** Strip to strip connector for static white strip



MOUNTING CHANNEL OPTIONS

- AL-RSM-6733**
- AL-RSM-6760**
- AL-RSM-7679-A**
- AL-RS-80106-R**
- AL-RS-80106-S**
- AL-RS-118**

Recommended Power Supplies

Dimmable with 0-10v, ELV, MLV, TRIAC



Item Number	Description	Max/Min Load	Input Voltage	Output Voltage	Dimmable	Dimensions
PS-TSLC-UNV-24V-30WDHV2	30W	30W / 3W	100-277V AC	24V DC	Yes*	6.49"L x 3.6"W x 1.02"H
PS-TSLC-UNV-24V-60WDHV2	60W	60W / 6W	100-277V AC	24V DC	Yes*	7.4"L x 3.6"W x 1.02"H
PS-TSLC-UNV-24V-96WDHV2	96W	96W / 9.6W	100-277V AC	24V DC	Yes*	8.66"L x 3.6"W x 1.61"H
PS-TSLC-UNV-24V-288WDHV2	288W (3 x 96W)	288W / 28.8W	100-277V AC	24V DC	Yes*	11.85"L x 4.25"W x 1.8"H





LED Strip Light

Assembly

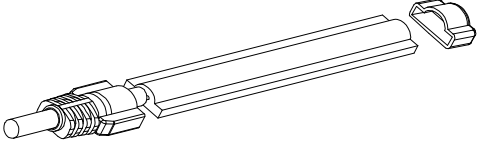
Option 1: Terminal is sealed with end cap by gluing process.

 1X End cap at the beginning  1X End cap at the tail	 <ol style="list-style-type: none"> <li data-bbox="459 566 954 622">Cut off the upper part of silicone jacket in 3mm[0.12in.] long, in order to expose the inner PCBA. <li data-bbox="970 566 1497 622">Put the power cable through the end cap at the beginning, and then solder the cable to the PCBA. <li data-bbox="459 846 954 902">Inject the glue to the interior of the end cap at the beginning, and then attach it to the LED strip. <li data-bbox="970 846 1497 902">Inject the glue to the interior of the end cap at the tail, and then attach it to the LED strip.
---	--

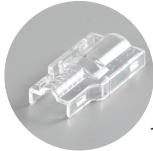
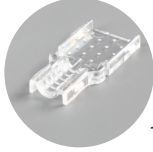
Option 2: Terminal is sealed with quick-assembly connector.

For The End Cap At The Beginning	
 1X Upper cover at the tail  1X Lower cover at the beginning  1X Power cable with conductive plate	<ol style="list-style-type: none"> <li data-bbox="459 1305 978 1361">Insert the power cable with conductive plate into the bottom of the PCBA and leave 2mm[0.08in.] outside. <li data-bbox="994 1305 1313 1339">Fix the strip light on the lower cover. <li data-bbox="459 1653 802 1731">Apply an appropriate amount of glue to the reserved 2mm[0.08in.] slot and fill the grooves and gaps. <li data-bbox="818 1653 1137 1709">Put the upper cover onto the bottom cover. <li data-bbox="1169 1653 1489 1731">Fasten the upper cover to the lower cover by plier, until the buckle is installed in place.

LED Strip Light

Assembly

Option 2: Terminal is sealed with quick-assembly connector.

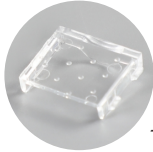
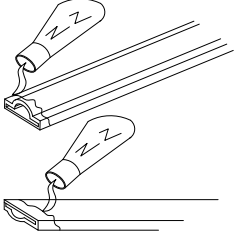
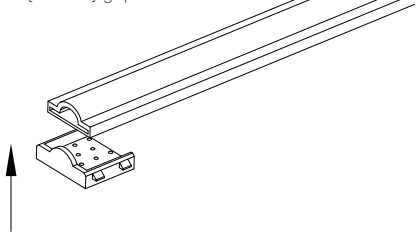
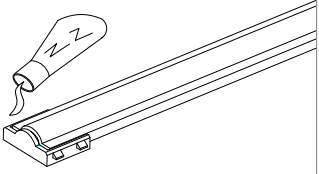
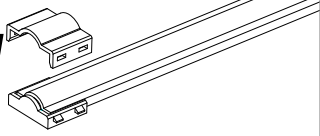
For The End Cap At The Tail		
 1X Upper cover at the tail  1X Lower cover at the tail	<p>① Apply an appropriate amount of glue around the edge of the strip light.</p> 	<p>② Fix the strip light on the lower cover and leave a 1mm[0.04in.] gap.</p> 
	<p>③ Apply an appropriate amount of glue to the reserved 1mm[0.04in.] slot and fill the grooves and gaps.</p> 	<p>④ Put the upper cover onto the bottom cover.</p> 

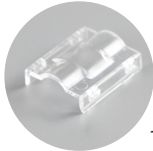
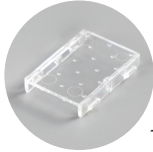
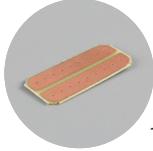
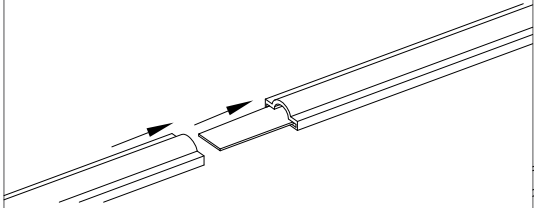
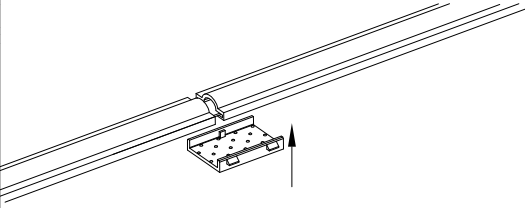
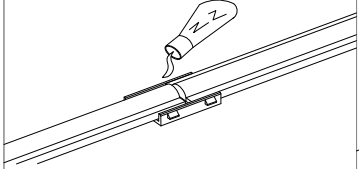
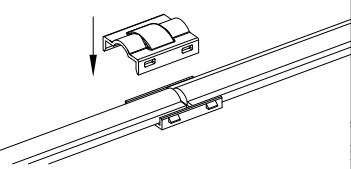
For The Extension Connector In The Middle		
 1X Upper cover of extension connector  1X Lower cover of extension connector  1X Conductive connection plate	<p>① Insert the conductive connection plate into the bottom of the PCBA of the two strip lights, and leave 2mm[0.08in.] outside in the middle.</p> 	<p>② Fix the two strip lights on the lower cover and align the limit structure.</p> 
	<p>③ Apply an appropriate amount of glue to the reserved 2mm[0.08in.] slot and fill the grooves and gaps.</p> 	<p>④ Put the upper cover onto the bottom cover.</p> 

LED Strip Light

Cutting

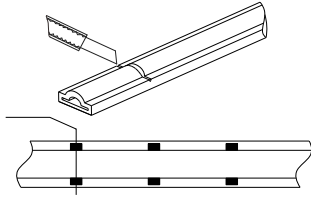

Find the corresponding cutting mark according to the length requirements, and then use a knife to cut open the top silicone jacket.

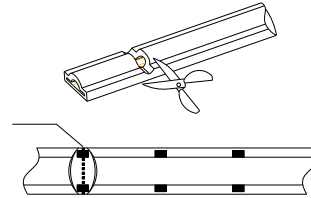

Bend the strip slightly upwards, and cut it along the inner PCBA's cutting line exposed from the opening with scissors.

Installation

Option 1: Fixed by 3M tape

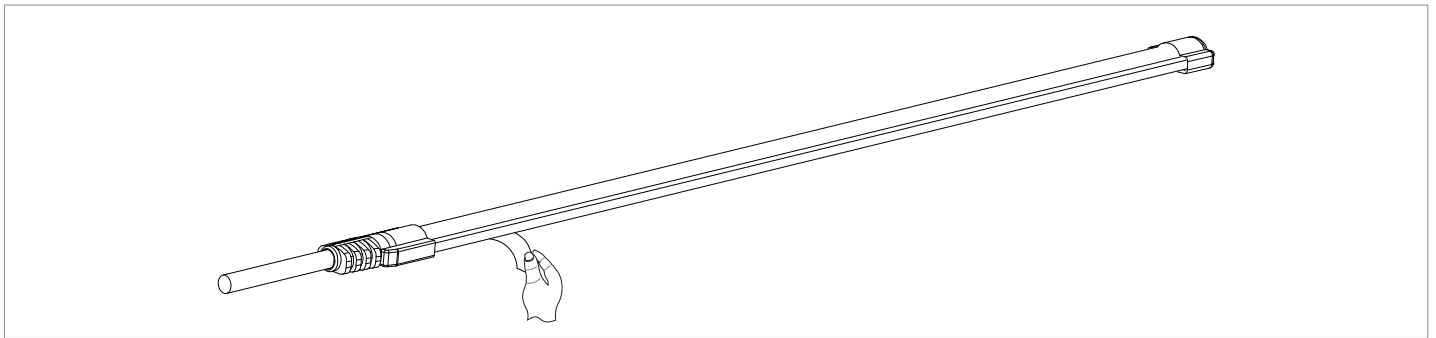

Option 2: Fixed by clip

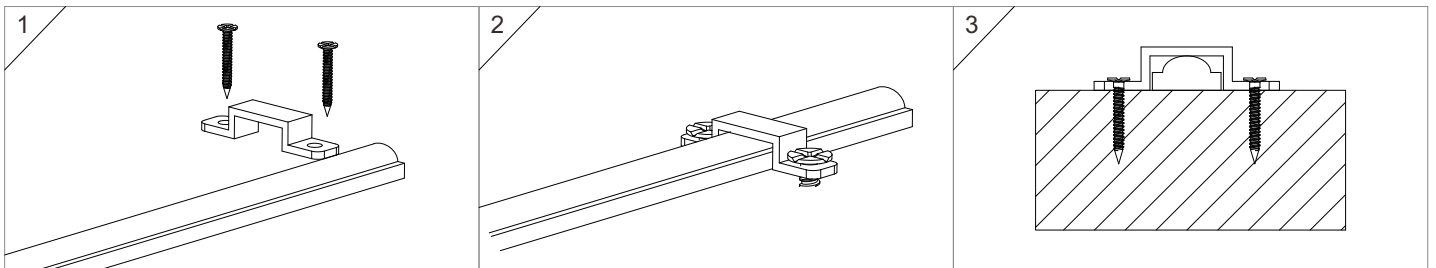

Option 3: Fixed by PC channel

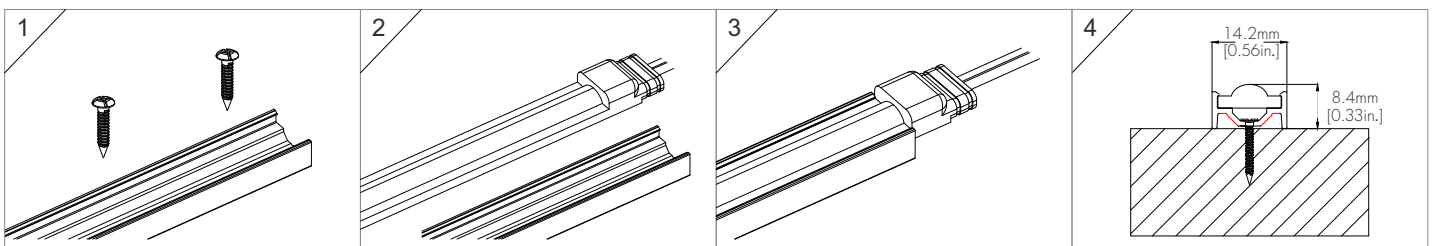

LED Strip Light

Connection

Non-dimmable Method

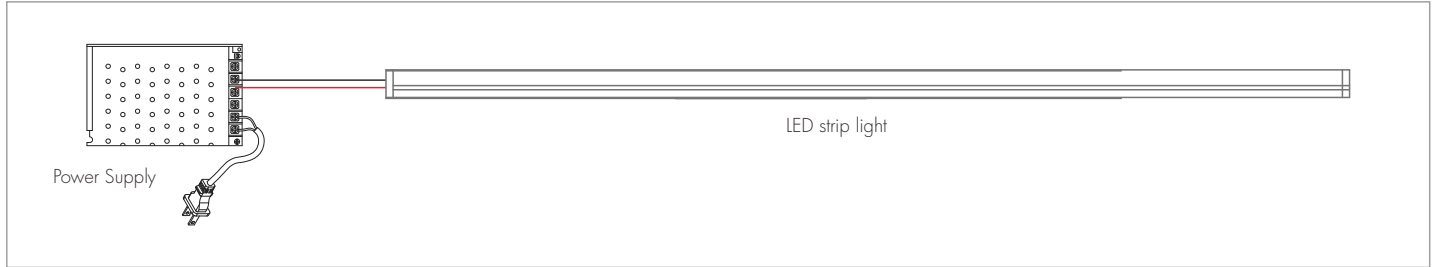

Dimmable Method

